

PUBLIC ADDRESS / SOUND KITS / ROOF

## KS-08WIFI

SOUND KIT 2 CEILING LOUDSPEAKERS WI-FI + BLUETOOTH



- ✓ High-quality, powerful stereo sound
- ✓ Wi-Fi receiver for music from online services and internet radio, with App
- ✓ Direct Bluetooth music receiver from your smartphone
- ✓ 2 x 25 W RMS built-in amplifier.



+ Info:  
<https://fonestar.com/KS-08WIFI>

ESPECIALLY RECOMMENDED IN:



Hospitality



Retail



Hotels



All sectors

## DESCRIPTION

Pair of Wi-Fi and Bluetooth® ceiling loudspeakers. Ideal sound kit for office or home use, in medium-sized rooms, kitchens, etc., consisting of active loudspeaker and passive loudspeaker. The Class D amplifier offers high reliability and sound quality, and high efficiency. The speakers are coaxial with 6 1/2" woofer and 1" tweeter. Enjoy powerful, high-quality sound. Play music from your smartphone, tablet, Windows or Mac. You can stream music directly via Bluetooth or via Wi-Fi with App for smartphones and tablets (iOS and Android) that allows control and streaming of music content. It can connect to online music services and internet radio, allows you to play music while receiving calls or using your smartphone for other applications without sound or notifications being played on the loudspeakers. You can send the same music programme to several speakers at the same time in multi-room mode (see note), or play different music programmes on each speaker. You can also select a different volume for each speaker and customise its name, among other options. In addition to the Bluetooth and Wi-Fi receiver, it has an auxiliary input for connecting another sound source. This great pair of speakers consists of an active loudspeaker with receiver and amplifier and a passive loudspeaker. Simple and elegant design that can be integrated into any environment. It is supplied with the necessary elements to start playing. Ideal sound kit for home and professional audio installations (offices, medium sized rooms, kitchens, waiting rooms, clinics, etc.).



+ Info:

<https://fonestar.com/KS-08WIFI>

## TECHNICAL CHARACTERISTICS

FEATURES	<p>Pair of Wi-Fi and Bluetooth ceiling loudspeakers.</p> <p>Active loudspeaker with amplifier and output for passive loudspeaker.</p> <p>Play music from your smartphone, tablet, Windows or Mac (DLNA and Airplay compatible).</p> <p>App for control from smartphones and tablets (iOS and Android), which allows connection to online music services and internet radio (WiiM).</p> <p>Bluetooth receiver.</p> <p>Line input.</p> <p>Multiroom function (see note).</p> <p>Frameless, low-profile grille.</p> <p>Remote control.</p>
BLUETOOTH	<p>5.0 Bluetooth.</p> <p>10 m transmission distance.</p>
AMPLIFIER	2 x 25 W RMS
SPEAKERS	Coaxial: 6 1/2" woofer, kevlar and 1" tweeter (active and passive) @ 8 Ohm
RESPONSE	80-20.000 Hz
INPUTS	<p>1 x stereo aux, 3.5 mm jack, 1 V RMS</p> <p>1 x RJ-45 Ethernet (Ethernet data connection)</p>
S/N RATIO	= < 92 dB
COLOUR	White
POWER SUPPLY	24 V DC, 3 A with adapter included
DIMENSIONS	<p>Loudspeakers</p> <p>230 mm Ø x 160 mm depth</p> <p>Cutting hole: 203 mm Ø</p>
WEIGHT	4 kg
ACCESSORIES	<p>5 m speaker cable</p> <p>Remote control</p> <p>Batteries for remote control</p>
NOTE	Possibility to change Bluetooth ID and password upon demand.



+ Info:

<https://fonestar.com/KS-08WIFI>

**SPL vs Frequency**

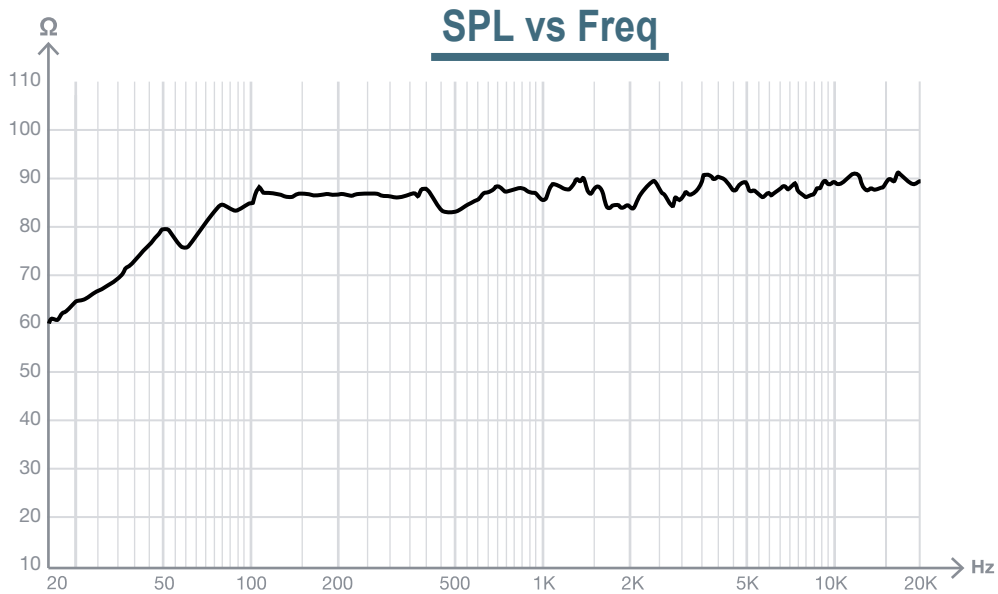

**SPL vs Angle**

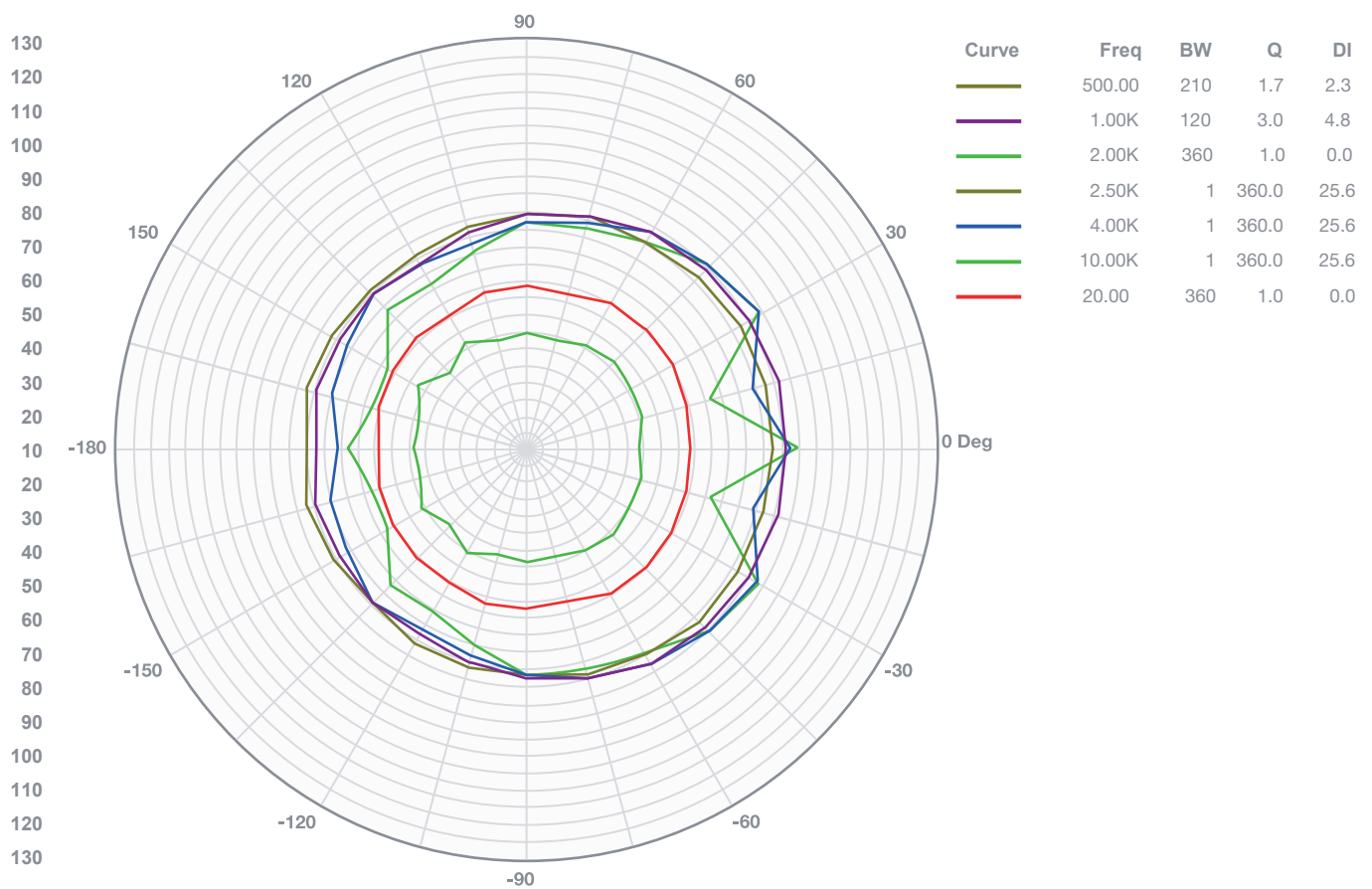

+ Info  
<https://fonestar.com/KS-08WIFI>



●  Impedance vs Frequency

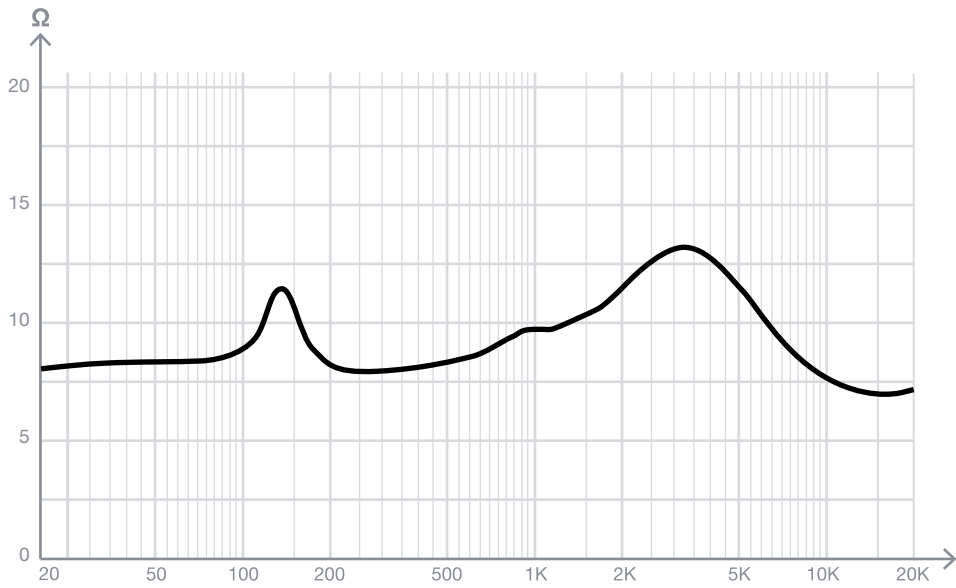

+ Info  
<https://fonestar.com/KS-08WIFI>

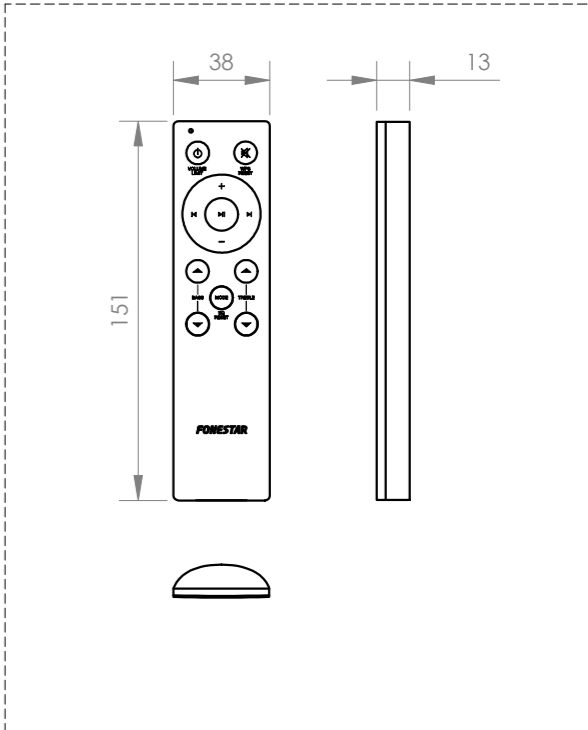
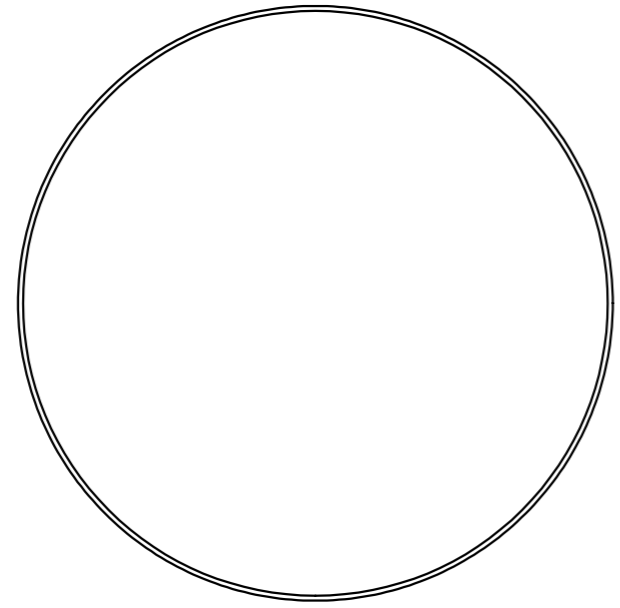
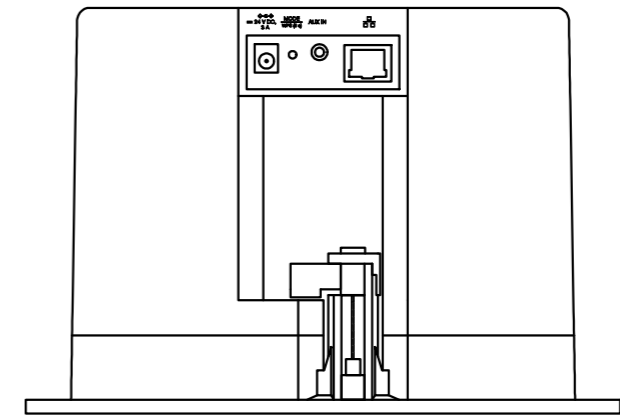
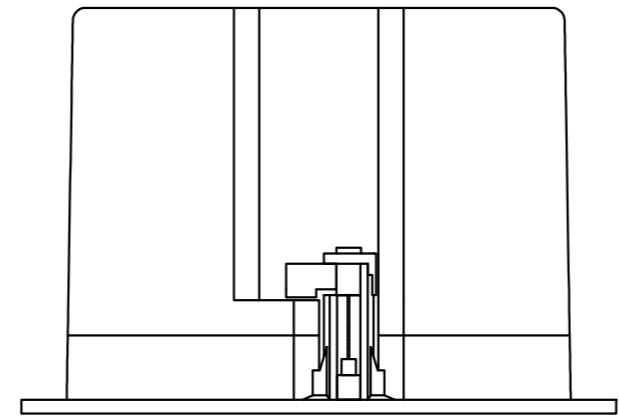
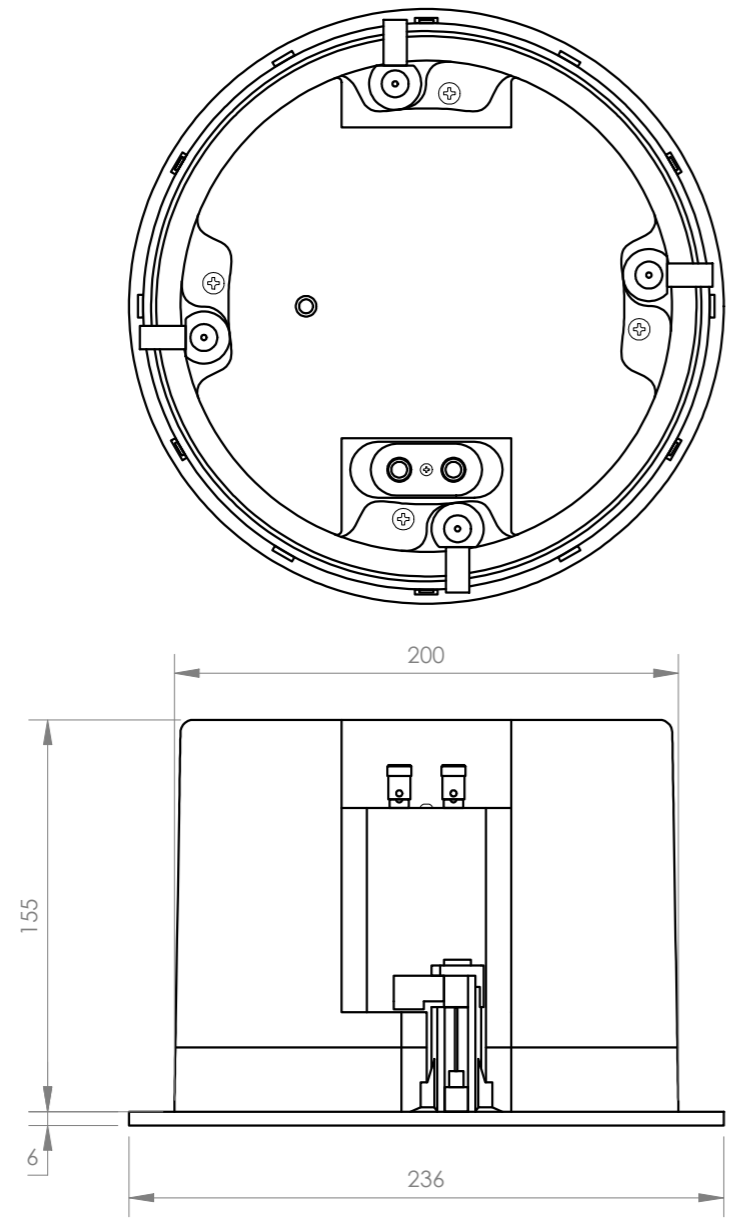

<b>FONESTAR</b>	Model	Description	Units	Scale
	KS-08WIFI	SOUND KIT 2 CEILING LOUDSPEAKERS WI-FI + BLUETOOTH	mm	1:3